

TR300VA002

Transformer 300 VA, 480/240/208/120 to 24 Vac, Circuit Breaker, Foot Mount, Dual End-Bell Openings

Transformer

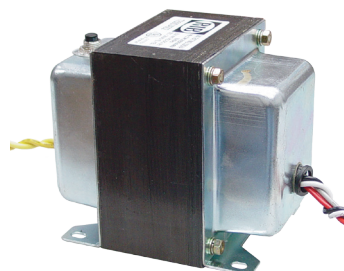
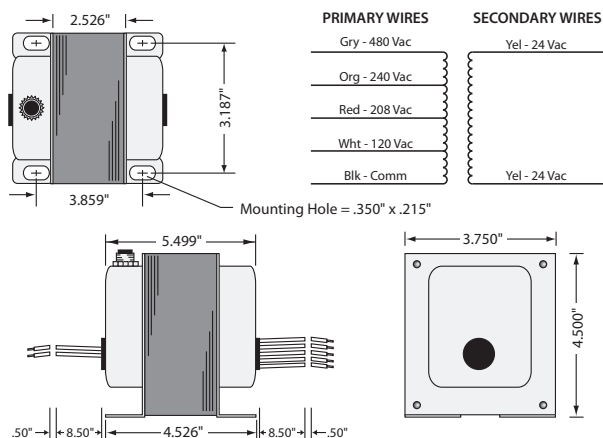

Specifications

- VA Rating:** 300
- Frequency:** 50/60 Hz
- Mounting:** Foot
- Over Current Protection:** Circuit Breaker
- Dimensions:** 5.499" x 3.750" x 4.500"
- Wire Length:** 8.5" Typical w/ .5" Strip
- Operating Temperature:** -30 to 140° F
- MTBF:** 100,000 Hours @ 77° F
- Construction:** Split-Bobbin
- Weight:** 11.60 lbs.
- Approvals:** UL5085-2 Component Recognized, C-UL, CE, RoHS